

SIDE BOW ROLLER CHAINS

ČZ Standard

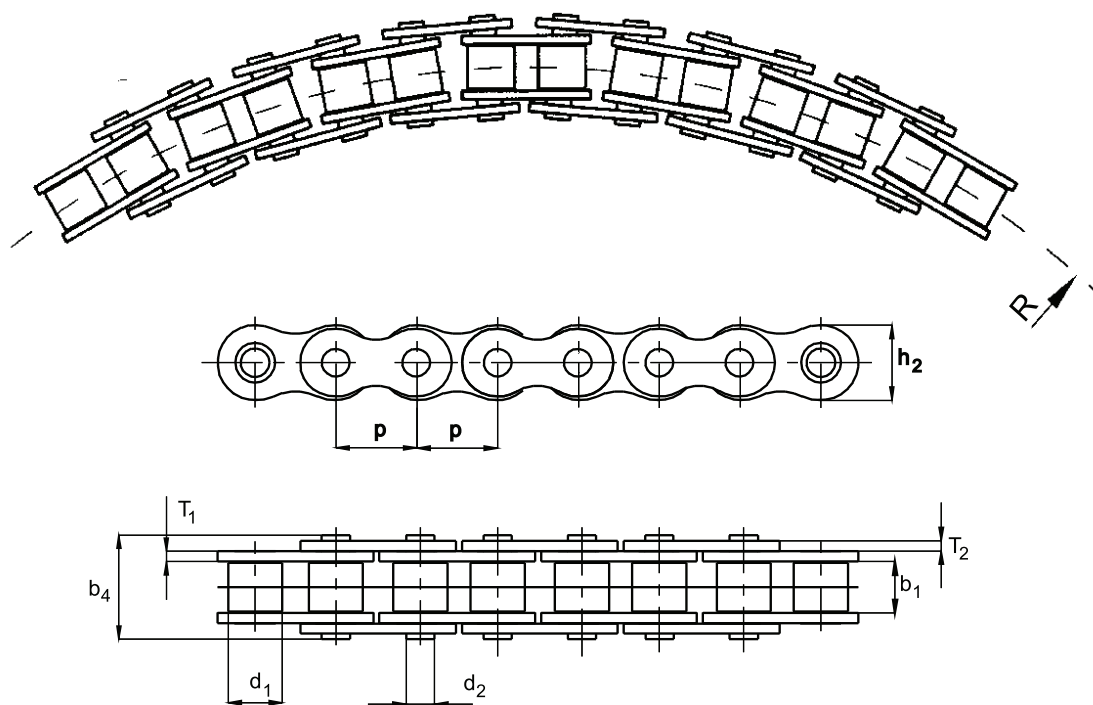

TRADE MARK ČZ	PITCH	INSIDE WIDTH	ROLLER DIAMETER	PIN DIAMETER	PIN LENGTH	INNER PLATE WIDTH	INNER PLATE THICKNESS	OUTER PLATE THICKNESS	SIDE BOW	BREAKING LOAD	CONNECTING ELEMENTS			
											B	A	E	S
	p	b1 min.	d1 max.	d2 max.	b4 max.	h2 max.	T1	T2	R	FB min.				
	mm	mm	mm	mm	mm	mm	mm	mm	mm	N				
08 B-1	12,7	7,75	8,51	4,45	16,80	11,80	1,60	1,40	370	18 690	•	•	•	•
10 B-1	15,875	9,65	10,16	5,08	19,30	14,50	1,60	1,60	500	23 310	•	•	•	•
12 B-1	19,05	11,68	12,07	5,72	22,30	16,10	1,80	1,80	650	30 345	•	•	•	•

CONNECTING ELEMENTS

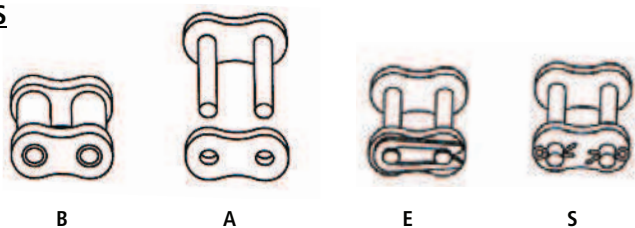

SIDE BOW ROLLER CHAINS WITH ATTACHMENTS M1, M2

ČZ Standard

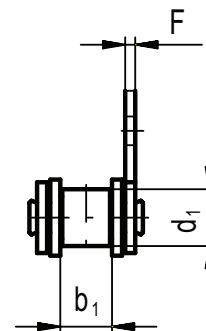
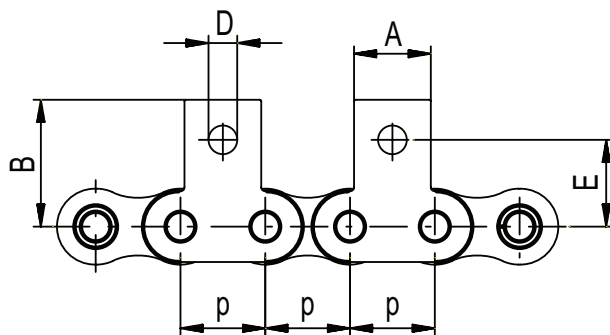
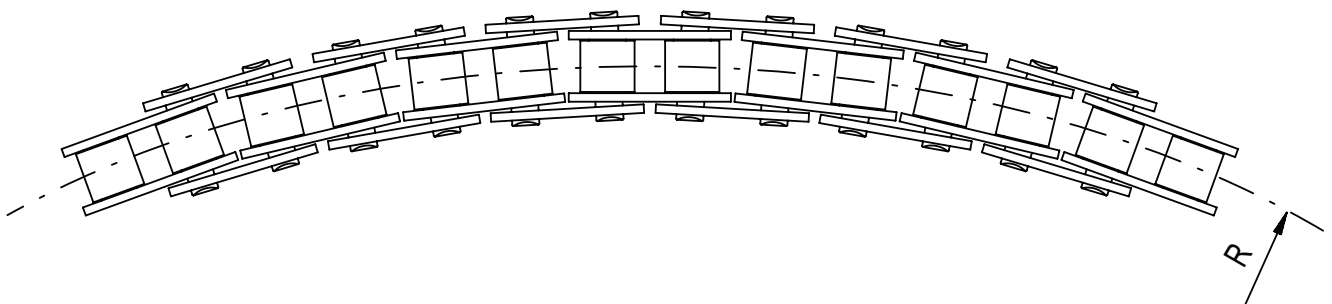

TYPE M1

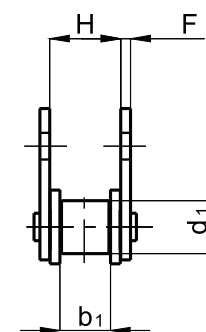

TYPE M2
R2

TRADE MARK ČZ	PITCH	INSIDE WIDTH	ROLLER DIAMETER	DIMENSION	DIMENSION	ATTACHMENT HOLE DIAMETER	DIMENSION	DIMENSION	ATTACHMENT PLATE THICKNESS	SIDE BOW	BREAKING LOAD
	p	b1 min.	d1 max.	A	B	D	E	H	F	R min.	FB min.
	mm	mm	mm	mm	mm	mm	mm	mm	mm	mm	N
08 B-1M1	12,7	7,75	8,51	11,50	19,00	4,30	13,00	-	1,40	400	18 690
08 B-1M2	12,7	7,75	8,51	11,50	19,00	4,30	13,00	11,90	1,40	400	18 690

Position of the attachments M1, M2 must be consulted with producer

SIDE BOW ROLLER CHAINS WITH ATTACHMENTS K1, K2

ČZ Standard

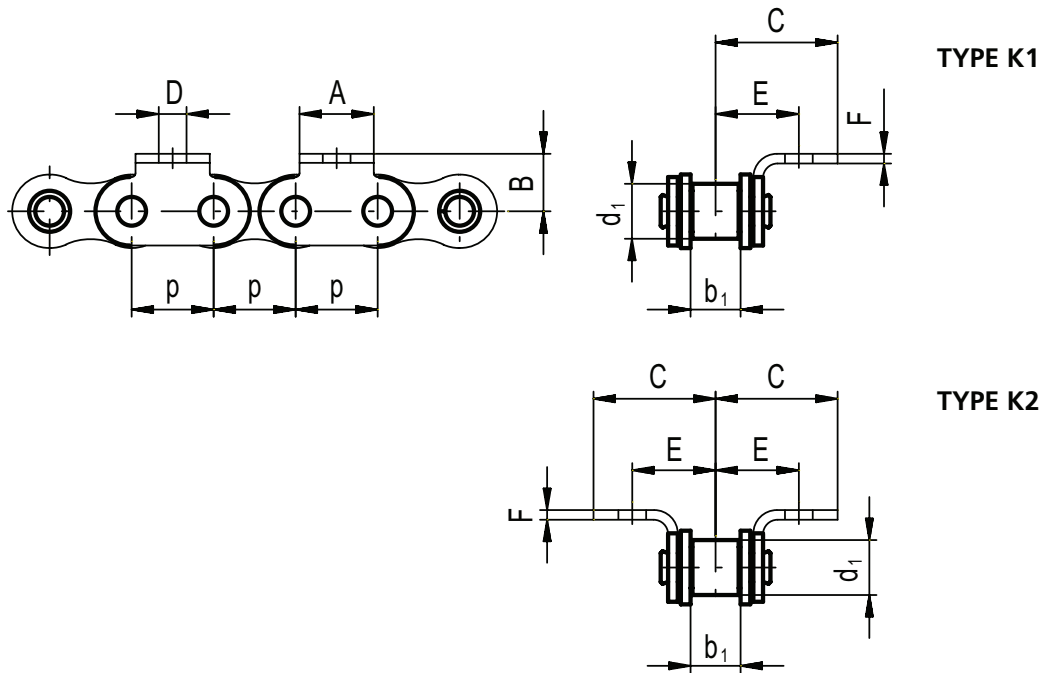
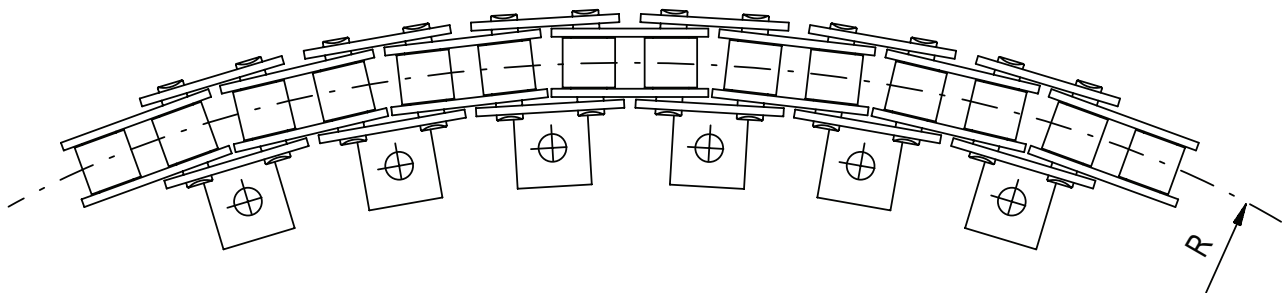

TRADE MARK ČZ	PITCH	INSIDE WIDTH	ROLLER DIAMETER	DIMENSION	DIMENSION	ATTACHMENT HOLE DIAMETER	DIMENSION	DIMENSION	ATTACHMENT PLATE THICKNESS	SIDE BOW	BREAKING LOAD
	p	b ₁ min.	d ₁ max.	A	B	D	E	C	F	R min.	FB min.
	mm	mm	mm	mm	mm	mm	mm	mm	mm	mm	N
08 B-1 K1	12,7	7,75	8,51	11,50	8,90	4,30	12,90	18,90	1,40	400	18 690
10 B-1 K1	15,875	9,65	10,16	14,00	10,30	5,30	16,20	24,20	1,60	500	23 310
10 B-1 K2	15,875	9,65	10,16	14,00	10,30	5,30	16,20	24,20	1,60	500	23 310

Position of the attachments K1, K2 must be consulted with producer

SIDE BOW ROLLER CHAINS WITH ATTACHMENTS K7, K8

ČZ Standard

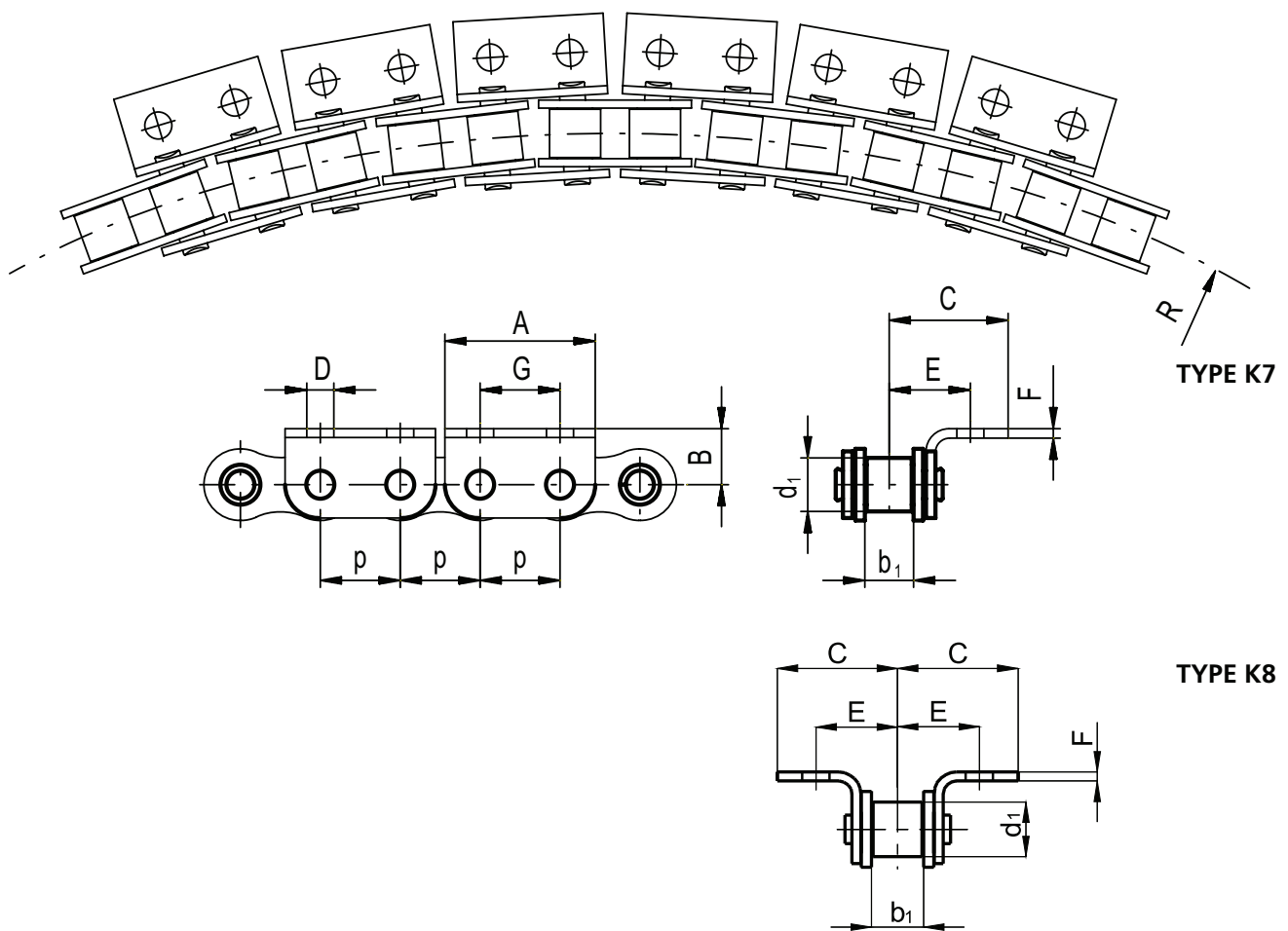

TRADE MARK ČZ	PITCH	INSIDE WIDTH	ROLLER DIAMETER	DIMENSION	DIMENSION	ATTACHMENT HOLE DIAMETER	DIMENSION	DIMENSION	DIMENSION	ATTACHMENT PLATE THICKNESS	SIDE BOW	BREAKING LOAD
	p	b1 min.	d1 max.	A	B	D	E	C	G	F	R min.	FB min.
	mm	mm	mm	mm	mm	mm	mm	mm	mm	mm	mm	N
08 B-1 K7	12,7	7,75	8,50	24,00	8,90	4,30	12,90	18,90	12,70	1,50	400	18 690
10 B-1 K8	15,875	9,65	10,16	28,70	10,30	5,30	16,30	24,30	15,88	1,50	500	23 310

SIDE BOW ROLLER CHAINS WITH ONE SIDE EXTENDED PINS

ČZ Standard

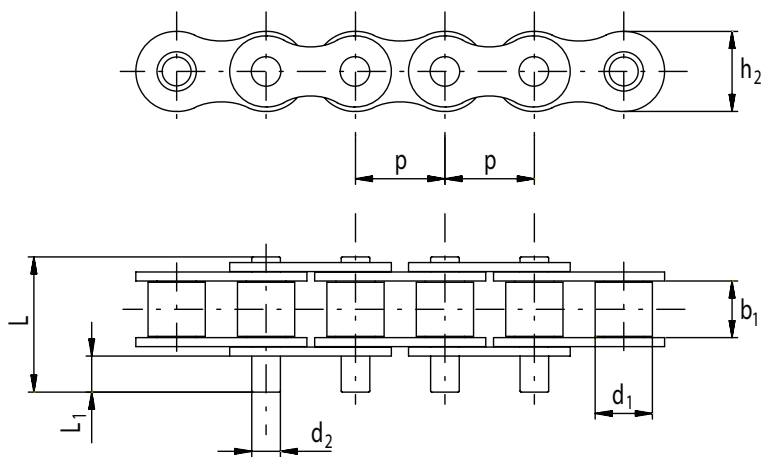
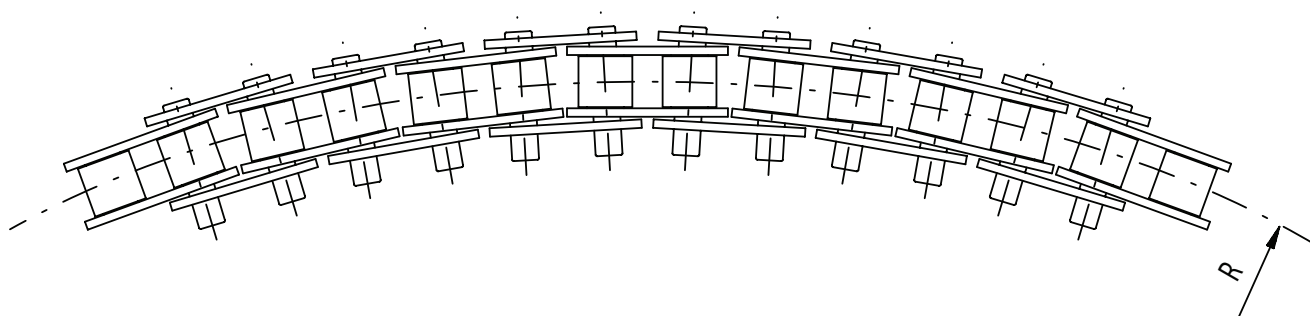

TRADE MARK ČZ	PITCH	INSIDE WIDTH	ROLLER DIAMETER	PIN DIAMETER	PIN LENGHT	PIN EXTENSION	INNER PLATE WIDTH	SIDE BOW	BREAKING LOAD
	p	b1 min.	d1 max.	d2 max.	L max.	L1 max.	h2 max.	R min.	FB min.
	mm	mm	mm	mm	mm	mm	mm	mm	N
08B-1	12,7	7,75	8,51	4,45	21,20	5,40	11,60	370	18 690

SIDE BOW ROLLER CHAINS WITH BOTH SIDE EXTENDED PINS

ČZ Standard

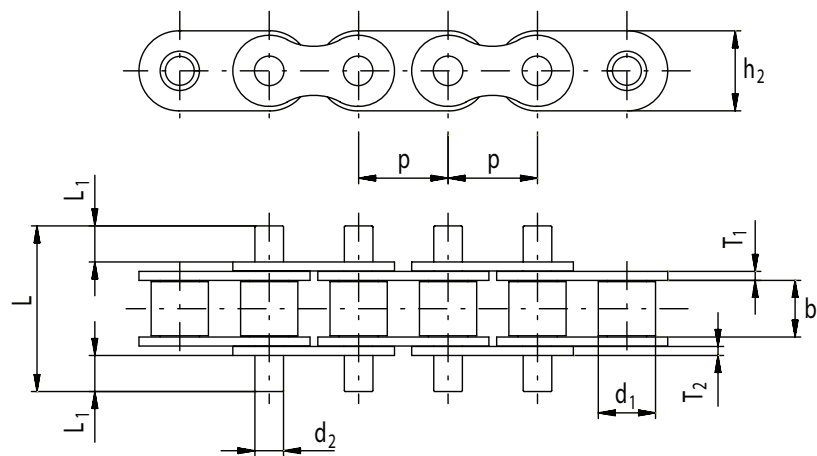
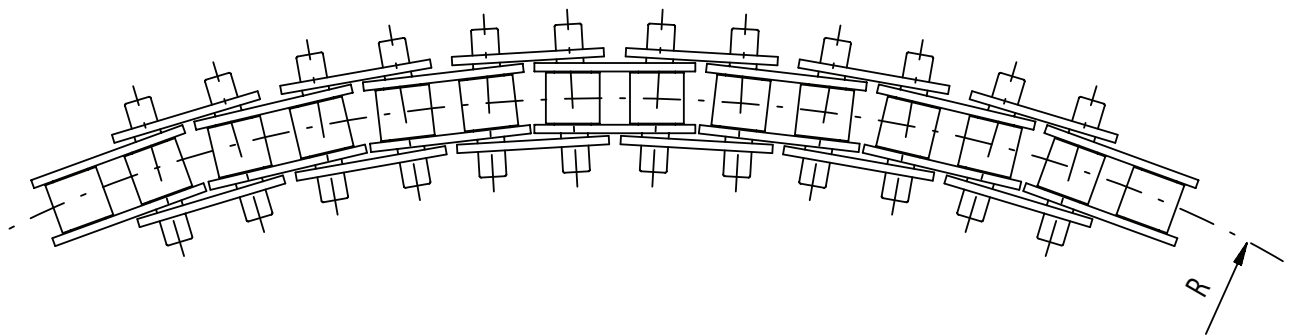

TRADE MARK ČZ	PITCH	INSIDE WIDTH	ROLLER DIAMETER	PIN DIAMETER	PIN LENGTH	PIN EXTENSION	INNER PLATE WIDTH	INNER PLATE THICKNESS	OUTER PLATE THICKNESS	SIDE BOW	BREAKING LOAD
	p	b1 min.	d1 max.	d2 max.	L max.	L1 max.	h2 max.	T1	T2	R min.	FB min.
	mm	mm	mm	mm	mm	mm	mm	mm	mm	mm	N
ASA 63	19,05	12,70	11,91	5,08	29,10	3,20	16,40	2,40	2,00	365	27 200